

**SERVICING MULTI-PIECE AND SINGLE-PIECE RIM WHEELS
29 CFR 1910.177**

**DEMOUNTING AND
MOUNTING PROCEDURES
FOR **TUBELESS** TRUCK
AND BUS TIRES**

**DEMOUNTING AND
MOUNTING PROCEDURES
FOR **TUBE-TYPE** TRUCK
AND BUS TIRES**

**MULTI-PIECE RIM
MATCHING CHART**



**Occupational Safety
and Health Administration**

U.S. Department of Labor

www.osha.gov

OSHA 3421-10N 2011

CONTENT

CHART 1	
DEMOUNTING AND MOUNTING PROCEDURES FOR TUBELESS TRUCK AND BUS TIRES.....	1
1 BEFORE SERVICING ANY TIRE RIM/WHEEL ASSEMBLY.....	2
2 DEFLATING AND DEMOUNTING TIRE FROM RIM/WHEEL ASSEMBLY.....	3
3 INSPECTING TIRE AND RIM/WHEEL COMPONENTS.....	4
4 MOUNTING TIRE ON RIM/WHEEL ASSEMBLY.....	5
5 INFLATING TIRE RIM/WHEEL ASSEMBLY.....	6
CHART 2	
DEMOUNTING AND MOUNTING PROCEDURES FOR TUBE-TYPE TRUCK AND BUS TIRES.....	8
1 BEFORE SERVICING ANY TIRE RIM/WHEEL ASSEMBLY.....	9
2 DEFLATING AND DEMOUNTING TIRE FROM RIM/WHEEL ASSEMBLY.....	10
3 INSPECTING TIRE AND RIM/WHEEL COMPONENTS.....	11
4 MOUNTING TIRE ON RIM/WHEEL ASSEMBLY.....	12
5 INFLATING TIRE RIM/WHEEL ASSEMBLY.....	13
CHART 3	
MULTI-PIECE RIM MATCHING CHART.....	15

DEMOUNTING AND MOUNTING PROCEDURES FOR **TUBELESS** TRUCK AND BUS TIRES

 **WARNING**

**TIRE AND RIM SERVICING CAN BE DANGEROUS
AND MUST ONLY BE PERFORMED BY
TRAINED PERSONNEL USING PROPER
PROCEDURES AND TOOLS.**

 **WARNING**

**FAILURE TO READ AND COMPLY WITH ALL OF
THESE PROCEDURES MAY RESULT IN SERIOUS
INJURY OR DEATH TO YOU AND OTHERS.**

PLEASE NOTE:

THIS IS CHART 1 OF A 3-CHART SET. BE SURE TO ALSO READ,
UNDERSTAND AND COMPLY WITH CHART 2 RE: DEMOUNTING AND MOUNTING
PROCEDURES FOR TUBE-TYPE TRUCK AND BUS TIRES, AND
CHART 3 RE: MULTI-PIECE RIM MATCHING

 **WARNING**

Completely deflate any tire by removing the valve core before removing the tire/wheel assembly from the axle if there is known or suspected damage to the tire or wheel or if the tire has been operated at 80% or less of its recommended operating pressure. Demount, inspect and match all tire and rim parts before re-inflating in a restraining device.

NEVER use starter fluid, ether, gasoline, or other flammable materials and/or accelerants to lubricate the beads of a tire. This practice can cause the explosive separation of the tire/wheel during servicing or during highway use, which may result in serious injury or death.

NEVER inflate beyond 40 psi to seat any tire beads.
NEVER stand, lean, or reach over the tire rim/wheel assembly in the restraining device during inflation. Even if a tire is in a restraining device, inflating beyond 40 psi when trying to seat the beads is a **DANGEROUS PRACTICE** that may break a tire bead or the rim/wheel with explosive force and possibly result in serious injury or death.

Any inflated tire mounted on a wheel contains explosive energy. The use of damaged, mismatched or improperly assembled tire and wheel components can cause the assembly to separate with explosive force. If struck by an exploding tire, wheel component, or the air blast, you or someone else may be seriously injured or killed.

Mismatching tire and rim diameters is dangerous. A mismatched tire and rim assembly may separate and can result in serious injury or death. This warning applies to 15" and 15.5", 16" and 16.5", 18" and 18.5", 22" and 22.5", 24" and 24.5" tire and rim assemblies as well as other sized assemblies. **NEVER** assemble a tire and rim unless you have positively identified and correctly matched the tire and rim diameter.

NEVER assemble a tire and rim unless you have positively identified and correctly matched the tire and rim diameter. If an attempt is made to seat the tire bead by inflating on a mismatched rim/wheel, the tire bead will break with explosive force and may result in serious injury or death.

1

BEFORE SERVICING ANY TIRE RIM/WHEEL ASSEMBLY

- **ALWAYS** comply with the procedures on this chart and in the tire/wheel manufacturer's catalogs, instruction manuals or other industry and government instructional materials.
- **Use a non-flammable vegetable or soap-based rubber lubricant** on the beads and rim surfaces to make tire demounting and mounting easier.
- **Use proper tools to demount or mount tires and rims** (refer to "Typical Tire Service Tools"). **NEVER** strike the tire/wheel assembly with a steel duck bill hammer to unseat the beads and do not strike the head of the hammer with another hard-faced hammer – use a rubber mallet or plastic dead blow hammer. Slide impact bead unseating tools are the preferred tools for unseating beads on tubeless tires.
- **NEVER** reinflate any tire that has been operated in a run-flat or underinflated condition (i.e., operated at 80% or less of recommended operating pressure). Demount, inspect and match all tire and rim components before reinflating in a restraining device with the valve core removed.
- **If an emergency puncture repair inflator was used on a tubeless tire**, deflate and inflate the tire several times to remove potentially explosive propellant before servicing the tire.

WARNING

**IF YOU DO NOT KNOW HOW TO USE TIRE SERVICING TOOLS — STOP!
TIRE SERVICING MUST ONLY BE PERFORMED BY TRAINED PERSONNEL.
FAILURE TO FOLLOW PROPER PROCEDURES CAN RESULT IN SERIOUS INJURY OR DEATH.**

- **ALWAYS** wear adequate protective eyewear (or face shield), protective footwear, and ear protection while servicing tires to avoid injury.
- **NEVER** use a tire tool for anything except demounting and mounting tires.
- **NEVER** use an extension or "cheater" bar with tire irons.
- **ALWAYS** use soft-faced hammers when driving tire irons or assembling components.
- **NEVER** use a hammer with a loose or cracked handle.
- **NEVER** use a bent, cracked, chipped, dented or mushroomed tool. Keep tools clean and inspect them frequently.
- **NEVER** alter or apply heat to any tire service tool.



2

DEFLATING AND DEMOUNTING TIRE FROM RIM/WHEEL ASSEMBLY

- **ALWAYS completely deflate** the tire assembly before attempting to demount. Remove the valve core and insert a wire down the valve stem to ensure complete deflation. **NEVER** demount a tire from a rim unless you are sure it is completely deflated.
- **Loosen beads** by using a slide impact bead unseating tool, duck bill hammer with a rubber mallet, or other bead unseating tools. Both beads must be loosened before demounting a tire.

TUBELESS; SINGLE PIECE

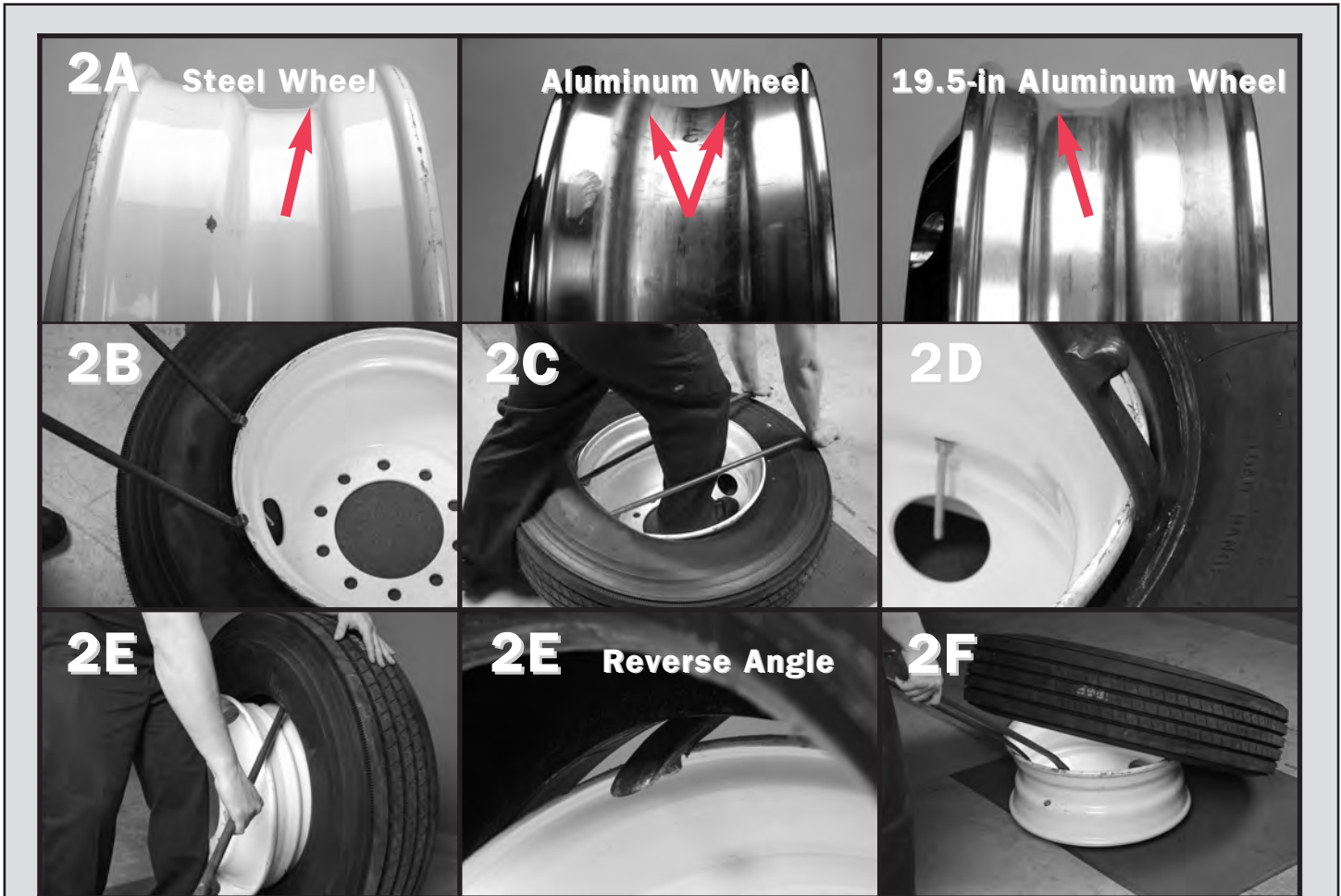

2A. Identify the short side of the drop center wheel well. Single piece tubeless rims and wheels must be demounted from the short side of the drop center well. On steel disc wheels, the short side is typically located opposite the disc. Aluminum wheels typically have symmetrical drop centers so tires can be demounted from either side. However, on certain 19.5-inch aluminum wheels, the short side of the drop center well is located on the disc side.

2B. Unseat and lubricate both beads. Position the assembly with the short side of the drop center well facing up.

2C. Insert tire irons on either side of the valve stem approximately 6 inches (152 mm) apart. Pry the top bead over the rim flange and force the bead opposite the tire irons in the drop center well.

2D. Remove one tire iron and insert the curved end between the bead and rim. Pry the rest of the top bead over the rim flange. Repeat this process until the first bead is entirely free from the rim.

2E. Stand the tire on its tread. Slide the flat end of the tire iron between the bead and the rim flange; make sure the tip is completely over the rim flange. Remove solid flange.

2F. Pry the tire iron and allow the rim/wheel to drop. **IMPORTANT!** Make sure your feet are clear of the rim. If necessary, rock or bounce the assembly to remove the tire from the rim/wheel. For aluminum wheels, a rubber mat should be placed on the floor to prevent damage to the mounting surface of the wheel.

3

INSPECTING TIRE AND RIM/WHEEL COMPONENTS

- **ALWAYS** conduct a visual and tactile inspection of the tire.
- **LOOK** and **FEEL** for any damage or evidence of being operated overloaded and/or in a run-flat condition (80% or less of its recommended operating inflation pressure).

Photo 3A is an example of innerliner damage created by an underinflated and overloaded condition.

⚠ WARNING Radial tires that have undulations or irregular sidewall distortions could possibly have permanent sidewall structural damage (steel cord fatigue). Ply cords weakened by underinflation and/or overloading may break one after another, until a rupture occurs in the upper sidewall with accompanying instantaneous air loss and explosive force. This can result in serious injury or death. Follow tire industry recommended inspection procedures for tires with these characteristics. Photo 3B is an example of sidewall undulations indicative of a potential “zipper rupture”.

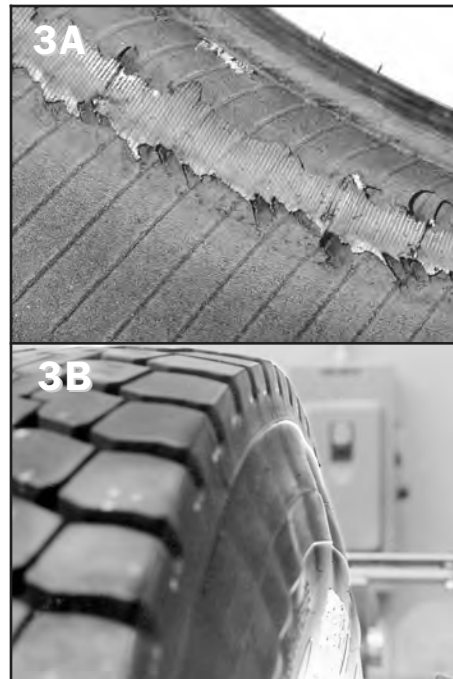

- Remove rust, dirt, or foreign material from all tire and rim/wheel mating surfaces.
- Inspect rim/wheel. **NEVER** use any single-piece rims/wheels that are worn, bent, cracked, or pitted by corrosion. Clearly mark and remove all unserviceable parts from the service area. See examples in 3C and 3D.
- **DO NOT** rework, weld, heat or braze any rim parts or components for any reason.

3C In the examples below, a rim flange wear guage can be used to determine if the rim flange is acceptable for service. The guage reads “Daylight in this area is an acceptable rim.”

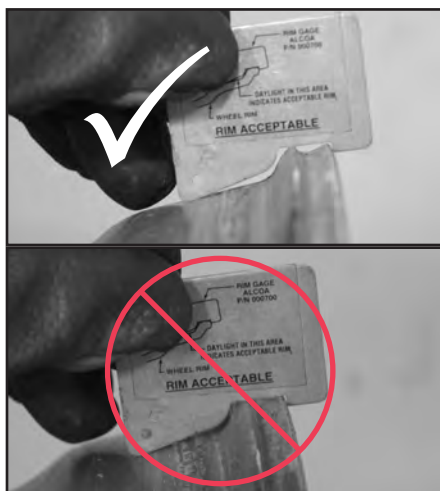

3D Use a carpenter square and a credit card to examine rim diameter.

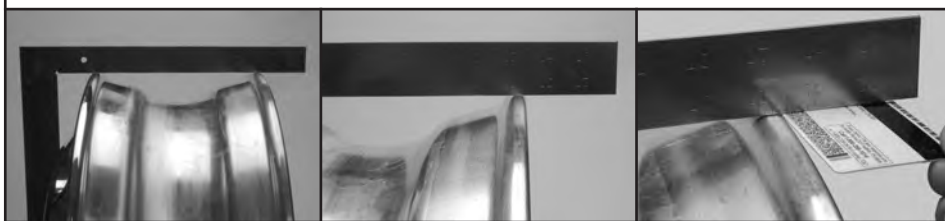

By using the carpenter square and the credit card on this wheel, it is more clear that the rim diameter has been reduced so the wheel should not be used. See WARNING below.

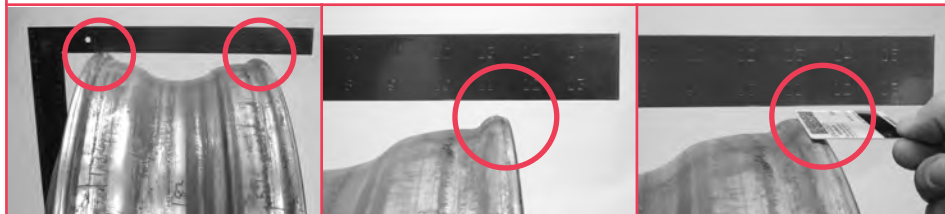

⚠ WARNING

ANY INFLATED TIRE MOUNTED ON A WHEEL CONTAINS EXPLOSIVE ENERGY. THE USE OF DAMAGED, MISMATCHED OR IMPROPERLY ASSEMBLED TIRE AND WHEEL COMPONENTS CAN CAUSE THE ASSEMBLY TO SEPARATE WITH EXPLOSIVE FORCE. IF STRUCK BY AN EXPLODING TIRE, WHEEL COMPONENT, OR THE AIR BLAST, YOU OR SOMEONE ELSE MAY BE SERIOUSLY INJURED OR KILLED.

4

MOUNTING TIRE ON RIM/WHEEL ASSEMBLY

TUBELESS; SINGLE-PIECE

4A. Before mounting, be sure that the tire is properly matched to the rim. These photo examples show the rim/wheel size stamp.

⚠ WARNING NEVER assemble a tire and rim unless you have positively identified and correctly matched the tire and rim diameter. If an attempt is made to seat the tire bead by inflating on a mismatched rim/wheel, the tire bead will break with explosive force and may result in serious injury or death.

4B. Identify the short side of the drop center well. Single-piece tubeless rims and wheels must be mounted from the short side of the drop center well. On steel disc wheels, the short side is typically located opposite the disc. Aluminum wheels typically have symmetrical drop centers so tires can be mounted from

either side. However, on certain 19.5-inch aluminum wheels, the short side of the drop center well is located on the disc side.

4C. Place the wheel on the floor with the short side of the drop center well facing up. **Lubricate** the tire beads and rim surfaces.

4D. Push the tire on the rim opposite the valve stem and use the curved end of the tire iron to pry the bottom bead over the rim flange.

4E. Apply pressure to the bead opposite the valve stem making sure the bead is completely in the drop center well.

4F. Taking small bites, use the curved end of the tire iron to pry the top bead over the rim flange. Keep the bead in the drop center well with your foot or a bead-locking device. Continue until the top bead is fully mounted over the rim flange.

BEFORE INFLATING TIRE RIM/WHEEL ASSEMBLY, THE TIRE MUST BE PROPERLY MOUNTED.

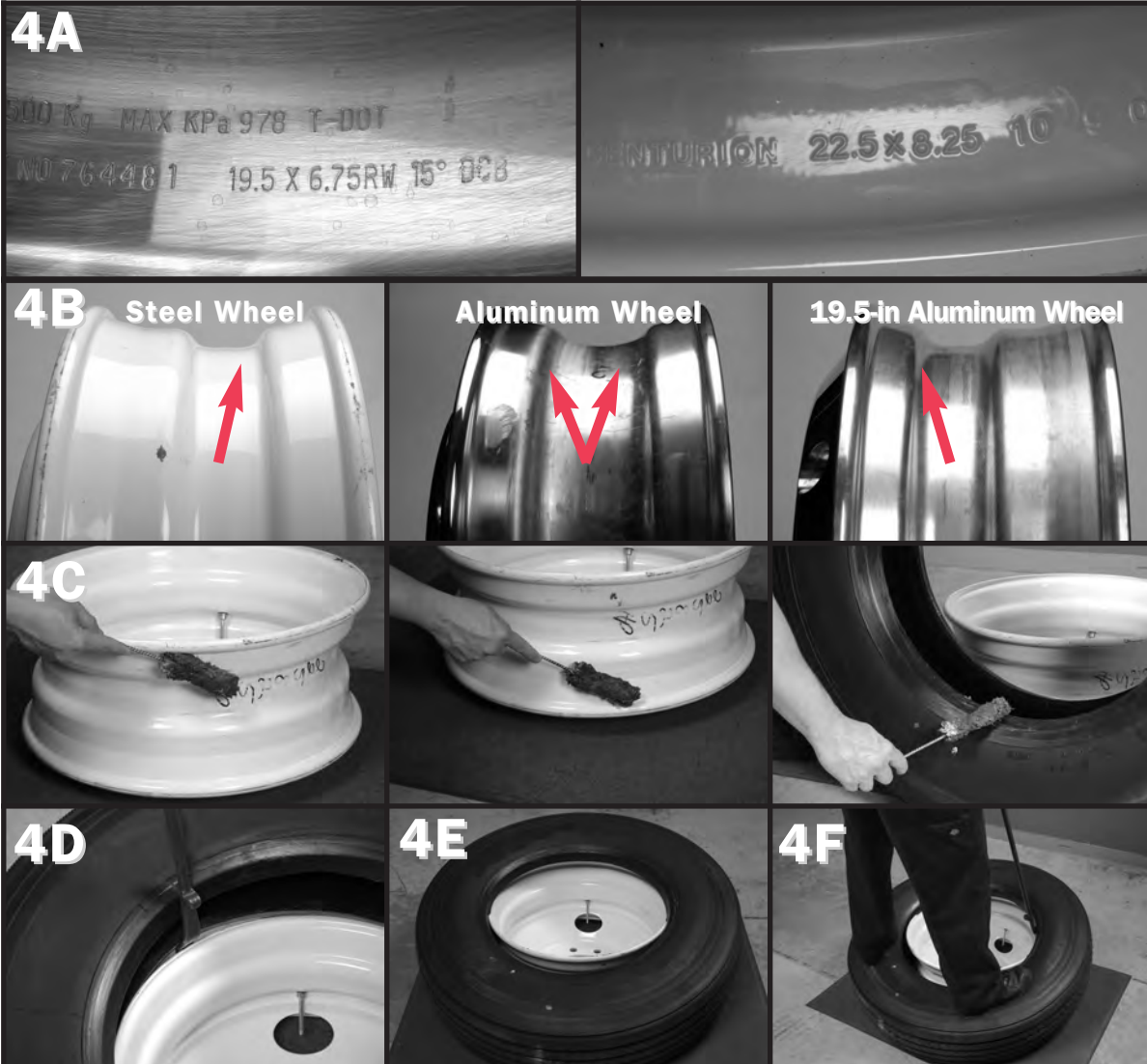

5

INFLATING TIRE RIM/WHEEL ASSEMBLY

⚠️ WARNING

TIRE AND RIM SERVICING CAN BE DANGEROUS AND MUST ONLY BE PERFORMED BY TRAINED PERSONNEL USING PROPER PROCEDURES AND TOOLS. FAILURE TO READ AND COMPLY WITH ALL OF THESE PROCEDURES MAY RESULT IN SERIOUS INJURY OR DEATH TO YOU AND OTHERS.

⚠️ WARNING NEVER use starter fluid, ether, gasoline, or other flammable materials and/or accelerants to lubricate or to seat the beads of a tire. This practice can cause the explosive separation of the tire/wheel during servicing or during highway use, which may result in serious injury or death.

⚠️ WARNING ALWAYS inflate the tire rim/wheel assembly in a restraining device with the valve core removed. The air line assembly must consist of the following components: a clip-on air chuck, an in-line valve with a pressure gauge or presettable regulator, and sufficient hose length to keep the technician outside the trajectory during inflation. (See “Trajectory” WARNING below.) **DO NOT** rest or lean any part of your body against the restraining device during inflation. Failure to use a restraining device when inflating a tire rim/wheel assembly is not only a violation of OSHA regulation 1910.177, but also a DANGEROUS PRACTICE that may result in serious injury or death.

⚠️ WARNING During inflation, if ANY sidewall undulations or bulges appear or if ANY snapping, cracking or popping noises occur — **STOP! DO NOT** approach tire. Before removing from restraining device, completely deflate tire remotely. Remove clip-on air chuck. Mark tire as damaged for potential “zipper rupture”. Render tire unservicable, non-repairable and scrap.

⚠️ WARNING NEVER inflate beyond 40 psi to seat any tire beads. **NEVER** stand, lean, or reach over the tire rim/wheel assembly in the restraining device during inflation. Even if a tire is in a restraining device, inflating beyond 40 psi when trying to seat the beads is a DANGEROUS PRACTICE that may break a tire bead or the rim/wheel with explosive force and possibly result in serious injury or death.

STEP-BY-STEP INFLATION PROCEDURES

1. Before inflating any tire rim/wheel assembly, be sure to read, understand and comply with ALL WARNINGS.
2. After mounting the tire on the rim, use a compressed air tank with quick release valve to seal the beads. **Do not exceed 5 psi before placing the assembly in a restraining device.**

3. Place the assembly in an OSHA-compliant restraining device, such as a tire safety cage. Photo 5A is an example of one type of a restraining device. Manufacturers recommend that restraining devices be freestanding and located at least one foot away from any flat or solid surface.

4. Inflate the tire, with the valve core removed, using a clip-on air chuck with an in-line valve or pressure regulator and a sufficient length of hose. **Inflate to 20 psi** in restraining device. **IMPORTANT!** Look for distortions, undulations, or other irregularities in the tire sidewall, such as in Photo 5C. Listen for any popping or snapping sounds. If ANY of these conditions are present — **STOP! DO NOT** approach tire. Before removing from restraining device, completely deflate tire remotely. Remove clip-on air chuck. Mark tire as damaged for potential “zipper rupture”. Render tire unservicable, non-repairable and scrap.

5. Visually inspect tire rim/wheel assemblies throughout the inflation process for improper seating. When inflating a tire, stay out of the trajectory. See “Trajectory” WARNING below. **DO NOT** stand or lean any part of your body against, or reach over, the restraining device during inflation.

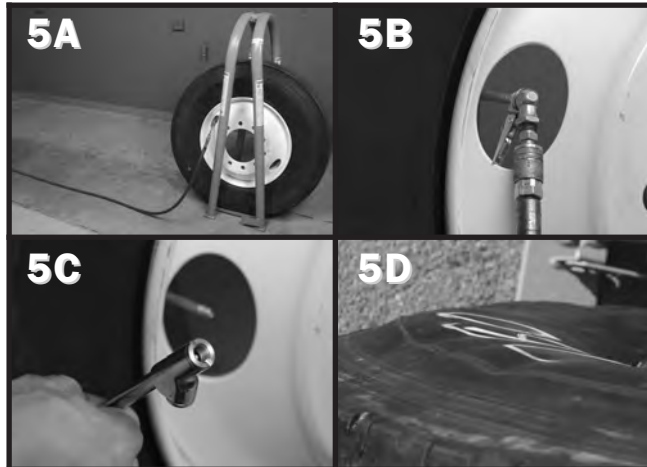

6. Continue to inflate until the beads are seated on the rim/wheel. Inspect both sides of the tire to be sure that the beads are evenly seated. **NEVER** inflate beyond 40 psi to seat any tire beads. If the beads are not seated at 40 psi — **STOP!** Completely deflate, remove from the restraining device, and determine the problem. Reposition the tire on the rim, relubricate, and reinflate.

7. After the tire beads are seated, continue to inflate the tire to its recommended inflation pressure. **IMPORTANT!** Look for distortions, undulations, or other irregularities in

the tire sidewall, such as in Photo 5D. Listen for any popping or snapping sounds. If ANY of these conditions are present — **STOP! DO NOT** approach tire. Before removing from restraining device, completely deflate tire remotely. Remove clip-on air chuck. Mark tire as damaged for potential “zipper rupture”. Render tire unservicable, non-repairable and scrap.

8. If none of these “zipper” conditions are present, **remove clip-on air chuck, install the valve core, and adjust the inflation pressure** to the recommended operating inflation pressure.

9. Before removing the tire rim/wheel assembly from the restraining device, always visually inspect for proper seating of the beads and all parts.

10. Conduct a final inspection. Check for air leaks. Install a suitable valve cap.

WARNING

TRAJECTORY

THE AIR PRESSURE CONTAINED IN A TIRE IS DANGEROUS. THE SUDDEN RELEASE OF THIS PRESSURE BY A TIRE BLOW-OUT OR SIDE RING SEPARATION CAN CAUSE SERIOUS INJURY OR DEATH. STAY OUT OF THE TRAJECTORY AS INDICATED BY THE SHADED AREA DEPICTED IN THE GRAPHICS. WHEN INSTALLING THE TIRE RIM/WHEEL ASSEMBLY ON THE VEHICLE, IT WILL BE IMPOSSIBLE TO STAY OUT OF THE TRAJECTORY. HOWEVER, AT ALL OTHER TIMES YOU AND ALL OTHERS MUST STAY OUT OF THE TRAJECTORY.

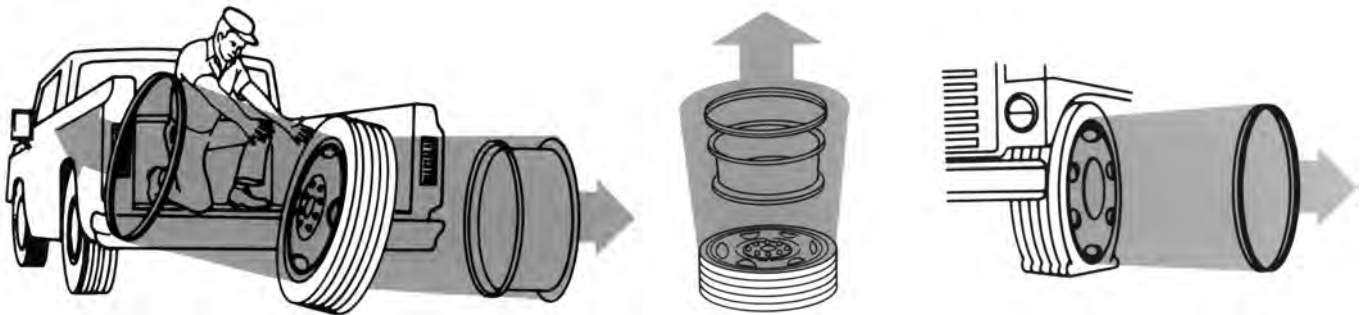

NOTE: Under some circumstances, the trajectory may deviate from its expected path.



**Occupational Safety
and Health Administration**

U.S. Department of Labor

www.osha.gov • (800) 321-OSHA (6742) • TTY (877) 889-5627

DEMOUNTING AND MOUNTING PROCEDURES FOR **TUBE-TYPE** TRUCK AND BUS TIRES

 **WARNING**

**TIRE AND RIM SERVICING CAN BE DANGEROUS
AND MUST ONLY BE PERFORMED BY
TRAINED PERSONNEL USING PROPER
PROCEDURES AND TOOLS.**

 **WARNING**

**FAILURE TO READ AND COMPLY WITH ALL OF
THESE PROCEDURES MAY RESULT IN SERIOUS
INJURY OR DEATH TO YOU AND OTHERS.**

PLEASE NOTE:

THIS IS CHART 2 OF A 3-CHART SET. BE SURE TO ALSO READ,
UNDERSTAND AND COMPLY WITH CHART 1 RE: DEMOUNTING AND MOUNTING
PROCEDURES FOR TUBELESS TRUCK AND BUS TIRES AND
CHART 3 RE: MULTI-PIECE RIM MATCHING

 **WARNING**

Completely deflate any tire by removing the valve core before removing the tire/wheel assembly from the axle if there is known or suspected damage to the tire or wheel or if the tire has been operated at 80% or less of its recommended operating pressure. Demount, inspect and match all tire and rim parts before re-inflating in a restraining device.

NEVER use starter fluid, ether, gasoline, or other flammable materials and/or accelerants to lubricate the beads of a tire. This practice can cause the explosive separation of the tire/wheel during servicing or during highway use, which may result in serious injury or death.

NEVER inflate beyond 40 psi to seat any tire beads.
NEVER stand, lean, or reach over the tire rim/wheel assembly in the restraining device during inflation. Even if a tire is in a restraining device, inflating beyond 40 psi when trying to seat the beads is a **DANGEROUS PRACTICE** that may break a tire bead or the rim/wheel with explosive force and possibly result in serious injury or death.

Any inflated tire mounted on a wheel contains explosive energy. The use of damaged, mismatched or improperly assembled tire and wheel components can cause the assembly to separate with explosive force. If struck by an exploding tire, wheel component, or the air blast, you or someone else may be seriously injured or killed.

Re-assembly and inflation of mismatched components on multi-piece tire and wheel assemblies can result in serious injury or death. Just because the components come in or fit together does not mean they are matched. Check the identification stamps for proper matching of all rim parts before assembling a multi-piece tire and wheel.

Mismatching tire and rim diameters is dangerous. A mismatched tire and rim assembly may separate and can result in serious injury or death. This warning applies to 15" and 15.5", 16" and 16.5", 18" and 18.5", 22" and 22.5", 24" and 24.5" tire and rim assemblies as well as other sized assemblies. **NEVER** assemble a tire and rim unless you have positively identified and correctly matched the tire and rim diameter.

1

BEFORE SERVICING ANY TIRE RIM/WHEEL ASSEMBLY

- **ALWAYS** comply with the procedures on this chart and in the tire/wheel manufacturer's catalogs, instruction manuals or other industry and government instructional materials.
- **Before loosening any nuts or clamps** that attach a tube-type tire/rim assembly to a vehicle, **ALWAYS** completely deflate the tire (or both tires of a dual assembly) by taking out the valve core(s).
- **Use a non-flammable vegetable or soap-based rubber lubricant** on the beads and rim surfaces to make tire demounting and mounting easier.
- **Use proper tools to demount or mount tires and rims** (refer to "Typical Tire Service Tools"). **NEVER** use a steel hammer to seat rim components—use only rubber, plastic or brass-tipped mallets. Striking a rim/wheel assembly with a hard-faced hammer can damage the components and endanger the installer. Use a steel duck bill hammer only as a wedge to unseat the beads of tube-type tires. **NEVER** strike the tire/wheel assembly with a steel duck bill hammer to unseat the beads and do not strike the head of the duck bill hammer with another hard-faced hammer – use a rubber mallet or plastic dead blow hammer. Slide impact tools and hydraulic bead unseating tools can also be used to unseat beads on tube-type tires.
- **NEVER** reinflate any tire that has been operated in a run-flat or underinflated condition (i.e., operated at 80% or less of recommended operating pressure). Demount, inspect and match all tire and rim components before reinflating in a restraining device with the valve core removed.

WARNING

**IF YOU DO NOT KNOW HOW TO USE TIRE SERVICING TOOLS — STOP!
TIRE SERVICING MUST ONLY BE PERFORMED BY TRAINED PERSONNEL.
FAILURE TO FOLLOW PROPER PROCEDURES CAN RESULT IN SERIOUS INJURY OR DEATH.**

- **ALWAYS** wear adequate protective eyewear (or face shield), protective footwear, and ear protection while servicing tires to avoid injury.
- **NEVER** use a tire tool for anything except demounting and mounting tires.
- **NEVER** use an extension or "cheater" bar with tire irons.
- **ALWAYS** use soft-faced hammers when driving tire irons or assembling components.
- **NEVER** use a hammer with a loose or cracked handle.
- **NEVER** use a bent, cracked, chipped, dented or mushroomed tool. Keep tools clean and inspect them frequently.
- **NEVER** alter or apply heat to any tire service tool.



2

DEFLATING AND DEMOUNTING TIRE FROM RIM/WHEEL ASSEMBLY

- **ALWAYS completely deflate** the tire assembly before attempting to demount. Remove the valve core and insert a wire down the valve stem to ensure complete deflation. **NEVER** demount a tire from a rim unless you are sure it is completely deflated.
- **Loosen beads** by using a slide impact bead unseating tool, duck bill hammer with a rubber mallet, or other bead unseating tools. Both beads must be loosened before demounting a tire.

TUBE-TYPE; MULTI-PIECE

CURRENT PRODUCTION: TWO-PIECE SOLID RIM; SPLIT RING - LW, FL

2A. Make sure the top bead is unseated and below the side ring before attempting to remove it. Insert the tapered end of the lock ring tool into the notch and pry the side ring out of the rim gutter. Lift wheel from assembly.

2B. Continue to remove the side ring by progressively prying around the rim. Use small bites to prevent distorting the side ring.

2C. Place a tire stand on the rim. Turn the assembly over. Unseat the bottom bead. Remove the tire from the rim. Remove the tube and flap from the tire.



CURRENT PRODUCTION: THREE-PIECE SOLID RIM; SPLIT LOCK RING; SOLID FLANGE-M, CR, 5 DEGREE

2D. Make sure the top bead is unseated and the flange is below the lock ring before attempting to remove the lock ring. Insert the tapered end of the lock ring tool into the notch and pry the lock ring out of the rim gutter. Lift wheel from assembly.

2E. Insert the lock ring tool between the lock ring and the flange. Remove the lock ring by progressively prying around the rim. Use small bites to prevent distorting the lock ring. Remove solid flange.

2F. Place a tire stand on the rim. Turn the assembly over. Unseat the bottom bead. Remove the tire from the rim. Remove the tube and flap from the tire.

CURRENT PRODUCTION MULTI-PIECE



OBSOLETE*: SPLIT RIM; SOLID RING-K

2G. Make sure the top bead is unseated and insert the tapered end of the lock ring tool into the notch in the rim near the split. Push the tool downward and toward the center of the rim. A block of wood may be placed under the left side of the rim split to help offset the rim base.

2H. Insert the tapered end of the lock ring tool into the second notch and push downward toward the center of the rim, prying the solid side ring from the rim. Remove the solid side ring.

2I. Place a tire stand on the rim. Turn the assembly over. Unseat the bottom bead. Remove the tire from the rim. Remove the tube and flap from the tire.



OBSOLETE MULTI-PIECE*

OBSOLETE*: SOLID RIM; SOLID RING-RH; 5 DEGREE

2J. Make sure the top bead is unseated and insert the tapered end of the lock ring tool into the notch in the solid side ring. This notch is located between the embossments on the solid side ring.

2K. Push the solid side ring downward at a point opposite the notch. Force the lock ring tool handle downward to pry the solid side ring from the rim. Continue prying around the rim until the solid side ring is free.

2L. Remove the solid side ring from the rim. Turn the assembly over and unseat the other bead. Remove the rim from the tire. * NOTE: These rims are no longer in production and replacement parts are not available.



3

INSPECTING TIRE AND RIM/WHEEL COMPONENTS

- **ALWAYS** conduct a visual and tactile inspection of the tire, rim/wheel and its components.
- **LOOK** and **FEEL** for any damage or evidence of being operated overloaded and/or in a run-flat condition (80% or less of its recommended operating inflation pressure).

Photo 3A is an example of innerliner damage created by an underinflated and overloaded condition.

⚠ WARNING Radial tires that have undulations or irregular sidewall distortions could possibly have permanent sidewall structural damage (steel cord fatigue). Ply cords weakened by underinflation and/or overloading may break one after another, until a rupture occurs in the upper sidewall with accompanying instantaneous air loss and explosive force. This can result in serious injury or death. Follow tire industry recommended inspection procedures for tires with these characteristics. Photo 3B is an example of sidewall undulations indicative of a potential “zipper rupture”.

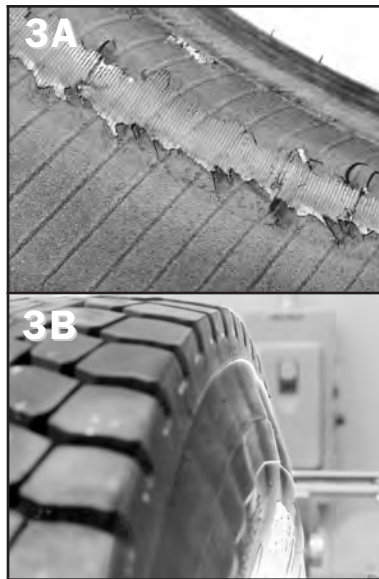

- Remove rust, dirt, or foreign material from all tire and rim/wheel mating surfaces.
- **NEVER** use any multi-piece rim parts that are worn, bent, cracked, or pitted by corrosion. Clearly mark and remove all unserviceable parts from the service area.
- **DO NOT** rework, weld, heat or braze any rim parts or components for any reason.
- **ALWAYS** find the identification stamp on multi-piece rim components. Check Chart 3 *Multi-Piece Rim Matching* to see that the parts are properly matched. **NEVER** use a rim part unless you can positively identify it from the markings stamped by the manufacturer. If you cannot identify a multi-rim component, **DO NOT USE IT.** (See WARNINGS.)

EXAMPLES OF UNSERVICEABLE PARTS

BENT, RUSTED, CRACKED, OR WORN PARTS CANNOT BE SAFELY ASSEMBLED AND MUST BE CLEARLY MARKED AND REMOVED FROM THE SERVICE AREA. REPLACE THEM WITH PROPERLY MATCHED, SERVICEABLE PARTS.

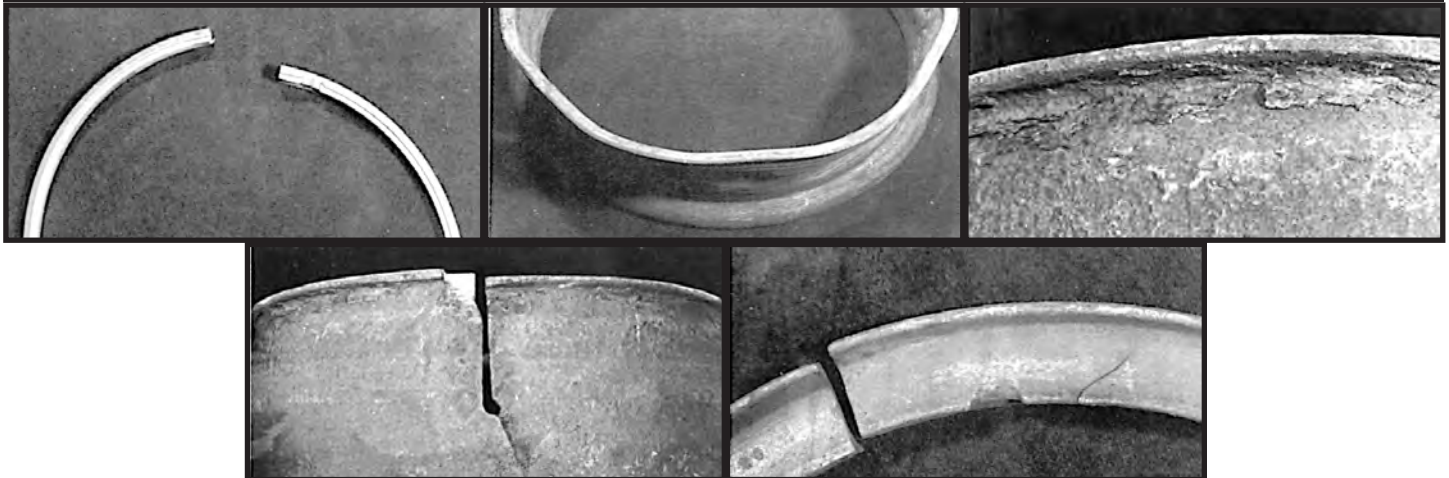

⚠ WARNING

ANY INFLATED TIRE MOUNTED ON A WHEEL CONTAINS EXPLOSIVE ENERGY. THE USE OF DAMAGED, MISMATCHED OR IMPROPERLY ASSEMBLED TIRE AND WHEEL COMPONENTS CAN CAUSE THE ASSEMBLY TO SEPARATE WITH EXPLOSIVE FORCE. IF STRUCK BY AN EXPLODING TIRE, WHEEL COMPONENT, OR THE AIR BLAST, YOU OR SOMEONE ELSE MAY BE SERIOUSLY INJURED OR KILLED.

4

MOUNTING TIRE ON RIM/WHEEL ASSEMBLY

TUBE-TYPE; MULTI-PIECE

BEFORE MOUNTING A TUBE-TYPE TIRE ON THE RIM/WHEEL ASSEMBLY, BE SURE TO INSTALL AN INNER TUBE AS FOLLOWS:

- Insert the tube into the tire and inflate with just enough air to round out the tube without creating wrinkles or creases.
- Insert the flap making sure the flap wings are not folded.
- Remove the valve core from the valve stem to prevent trapped air from interfering with the proper seating of the side or lock ring into the rim gutter.

BEFORE INFLATING TIRE RIM/WHEEL ASSEMBLY, ALL RIM PARTS MUST BE PROPERLY MATCHED AND INSTALLED.

TWO-PIECE

INCORRECT

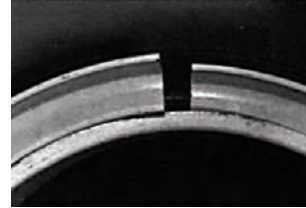

CORRECT

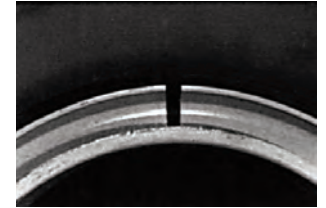

THREE-PIECE

INCORRECT



CORRECT

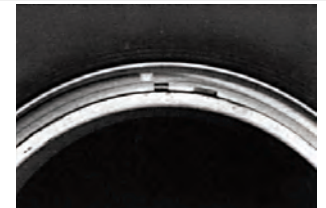

CURRENT PRODUCTION: TWO-PIECE SOLID RIM; SPLIT RING - LW, FL

4A. Lay the rim on the floor and align the valve stem with the slot in the rim. Lift the tire at the valve stem to work it onto the rim. For rims with bead humps, make sure the top bead is below the bead hump before attempting to install the side ring.



4B. Insert one end of the side ring into the rim gutter and use a rubber mallet or dead-blow hammer to progressively seat the remainder of the side ring in the rim gutter.



CURRENT PRODUCTION: THREE-PIECE SOLID RIM; SPLIT LOCK RING; SOLID FLANGE-M, CR, 5 DEGREE

4C. Lay the rim on the floor and align the valve stem with the slot in the rim. Lift the tire at the valve stem to work it onto the rim. For rims with bead humps, make sure the top bead is below the bead hump before attempting to install the side ring. Install the flange making sure it is below the rim gutter.



4D. Insert the end of the lock ring in the rim gutter and use a rubber mallet or dead-blow hammer to progressively seat the remainder of the lock ring in the rim gutter.



4E. Ensure the lock ring is completely seated in the rim gutter by using the rubber mallet or dead-blow hammer before attempting to inflate the tire.





5

INFLATING TIRE ON RIM/WHEEL ASSEMBLY

WARNING

TIRE AND RIM SERVICING CAN BE DANGEROUS AND MUST ONLY BE PERFORMED BY TRAINED PERSONNEL USING PROPER PROCEDURES AND TOOLS. FAILURE TO READ AND COMPLY WITH ALL OF THESE PROCEDURES MAY RESULT IN SERIOUS INJURY OR DEATH TO YOU AND OTHERS.

 **WARNING** If the parts are not seated properly, deflate the tire and correct the problem before proceeding. **NEVER** attempt to seat any part on a multi-piece tire/rim assembly by hammering, striking or prying while the tire contains inflation pressure. Striking the assembly in this manner is a DANGEROUS PRACTICE that may result in serious injury or death.

 **WARNING ALWAYS** inflate the tire rim/wheel assembly in a restraining device with the valve core removed. The air line assembly must consist of the following components: a clip-on air chuck, an in-line valve with a pressure gauge or presettable regulator, and sufficient hose length to keep the technician outside the trajectory during inflation. (See “Trajectory” WARNING below.) **DO NOT** rest or lean any part of your body against the restraining device during inflation. Failure to use a restraining device when inflating a tire rim/wheel assembly is not only a violation of OSHA regulation 1910.177, but also a DANGEROUS PRACTICE that may result in serious injury or death.

 **WARNING** During inflation, if ANY sidewall undulations or bulges appear or if ANY snapping, cracking or popping noises occur — **STOP! DO NOT** approach tire. Before removing from restraining device, completely deflate tire remotely. Remove clip-on air chuck. Mark tire as damaged for potential “zipper rupture”. Render tire unservicable, non-repairable and scrap.

 **WARNING NEVER** inflate beyond 40 psi to seat any tire beads. **NEVER** stand, lean, or reach over the tire rim/wheel assembly in the restraining device during inflation. Even if a tire is in a restraining device, inflating beyond 40 psi when trying to seat the beads is a DANGEROUS PRACTICE that may break a tire bead or the rim/wheel with explosive force and possibly result in serious injury or death.

STEP-BY-STEP INFLATION PROCEDURES

1. Before inflating any tire rim/wheel assembly, be sure to read, understand and comply with ALL WARNINGS. For a tube-type tire, be certain that the side or lock ring is properly seated.
2. After mounting the tire on the rim, inflate to approximately 5 psi to seat the beads.
3. Place the assembly in an OSHA-compliant restraining device, such as a tire safety cage. Photo 5A is an example of a portable device. Manufacturers recommend that restraining devices be free-standing and located at least one foot away from any flat or solid surface.
4. Inflate the tire, with the valve core removed, using a clip-on air chuck with an in-line valve or pressure regulator and a sufficient length of hose. Inflate to 20 psi in restraining device. For tube-type tires, the tire can be deflated after reaching 20 psi and re-inflated to prevent inner tube wrinkles. **IMPORTANT!** Look for distortions, undulations, or other irregularities in the tire sidewall, such as in Photo 5B. Listen for any popping or snapping sounds. If ANY of these conditions are present — **STOP! DO NOT** approach tire. Before removing from restraining device, completely deflate tire remotely. Remove clip-on air chuck. Mark tire as damaged for potential “zipper rupture”. Render tire unservicable, non-repairable and scrap.



5. Visually inspect multi-piece tire rim/wheel assemblies throughout the inflation process for improper seating of the rings and/or beads. When inflating a tire, stay out of the trajectory. (See “Trajectory” Warning below.) **DO NOT** stand or lean any part of your body against, or reach over, the restraining device during inflation.
6. Continue to inflate until the beads are seated on the rim/wheel. Inspect both sides of the tire to be sure that the beads are evenly seated. **NEVER** inflate beyond 40 psi to seat any tire beads. If the beads are not seated at 40 psi — **STOP!** Completely deflate, remove from the restraining device, and determine the problem. Reposition the tire and/or inner tube on the rim, relubricate, and reinflate.
7. After the tire beads are seated, continue to inflate the tire to its recommended inflation pressure. **IMPORTANT!** Look for distortions, undulations, or other irregularities in the tire sidewall, such as in Photo 5B. Listen for any popping or snapping sounds. If ANY of these conditions are present — **STOP! DO NOT** approach tire. Before removing from restraining device, completely deflate tire remotely. Remove clip-on air chuck. Mark tire as damaged for potential “zipper rupture”. Render tire unservicable, non-repairable and scrap.
8. If none of these “zipper” conditions are present, remove clip-on air chuck, install the valve core, and adjust the inflation pressure to the recommended operating inflation pressure.
9. Before removing the tire rim/wheel assembly from the restraining device, always visually inspect for proper seating of the beads and all parts.
10. Conduct a final inspection. Check for air leaks. Install a suitable valve cap.

WARNING

TRAJECTORY

THE AIR PRESSURE CONTAINED IN A TIRE IS DANGEROUS. THE SUDDEN RELEASE OF THIS PRESSURE BY A TIRE BLOW-OUT OR SIDE RING SEPARATION CAN CAUSE SERIOUS INJURY OR DEATH. STAY OUT OF THE TRAJECTORY AS INDICATED BY THE SHADED AREA DEPICTED IN THE GRAPHICS. WHEN INSTALLING THE TIRE RIM/WHEEL ASSEMBLY ON THE VEHICLE, IT WILL BE IMPOSSIBLE TO STAY OUT OF THE TRAJECTORY. HOWEVER, AT ALL OTHER TIMES YOU AND ALL OTHERS MUST STAY OUT OF THE TRAJECTORY.

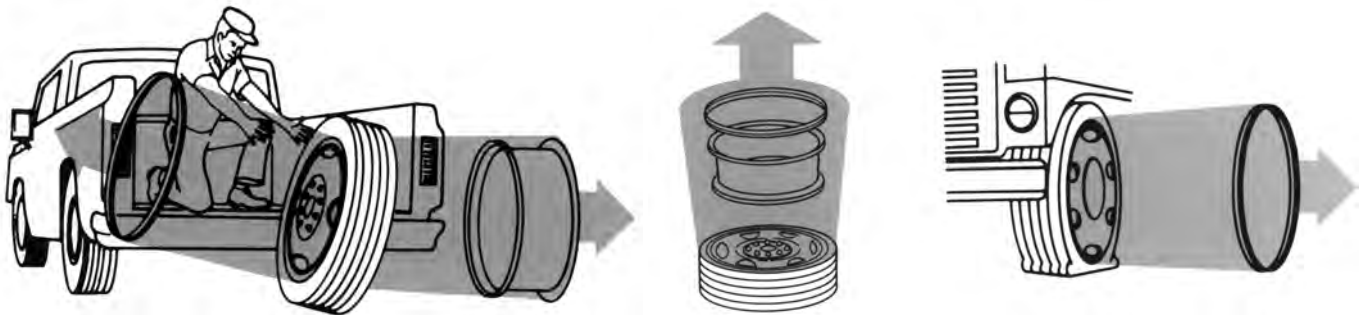

NOTE: Under some circumstances, the trajectory may deviate from its expected path.



**Occupational Safety
and Health Administration**

U.S. Department of Labor

www.osha.gov • (800) 321-OSHA (6742) • TTY (877) 889-5627

MULTI-PIECE RIM MATCHING CHART

! WARNING

TIRE AND RIM SERVICING CAN BE DANGEROUS AND MUST ONLY BE PERFORMED BY TRAINED PERSONNEL USING PROPER PROCEDURES AND TOOLS.

! WARNING

FAILURE TO READ AND COMPLY WITH ALL OF THESE PROCEDURES MAY RESULT IN SERIOUS INJURY OR DEATH TO YOU AND OTHERS.

PLEASE NOTE:

THIS IS CHART 3 OF A 3-CHART SET. BE SURE TO ALSO READ, UNDERSTAND AND COMPLY WITH CHART 1 RE: DEMOUNTING AND MOUNTING PROCEDURES FOR TUBELESS TRUCK AND BUS TIRES AND CHART 2 RE: DEMOUNTING AND MOUNTING PROCEDURES FOR TUBE-TYPE TRUCK AND BUS TIRES

DISCONTINUED PARTS

RIM REPLACEMENT PARTS THAT ARE OBSOLETE, DISCONTINUED OR NO LONGER IN PRODUCTION ARE SHADED IN RED.

If you are working on a rim/wheel assembly of discontinued parts that are cracked, bent, worn, pitted by corrosion, or unserviceable in any way, for whatever reason — **STOP!** You must discard all damaged components.

EXAMPLES OF UNSERVICEABLE PARTS

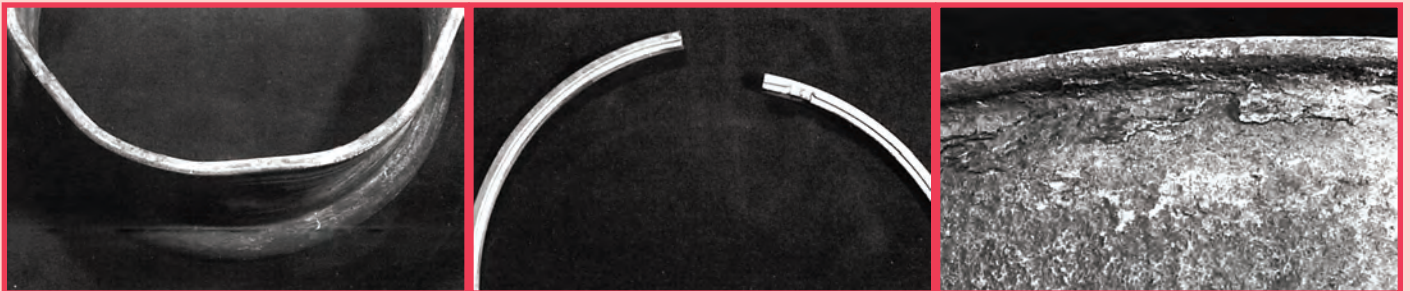

RIM PARTS NOT SHOWN IN CHART

THIS CHART IS NOT ALL-INCLUSIVE. Rim parts marked with **EXACTLY** the same size and type identification stamps may be used together even though they are not shown on this chart. Rim parts marked with different size and type identification stamps should **NEVER** be used together. Just because components come in together, does not mean they are matched. See WARNINGS.

! WARNING

ALWAYS comply with the procedures on this chart and in the wheel manufacturers' catalogs, instruction manuals or other industry and government instruction materials. Failure to do so may cause serious injury or death for you and others.

Any inflated tire mounted on a wheel contains explosive energy. The use of damaged, mismatched or improperly assembled tire and wheel components can cause the assembly to separate with explosive force. If struck by an exploding tire, wheel component, or the air blast, you or someone else may be seriously injured or killed.

Re-assembly and inflation of mismatched components on multi-piece tire and wheel assemblies can result in serious injury or death. Just because the components come in together does not mean they are matched. Check identification stamps for proper matching of all rim parts before assembling a multi-piece tire and wheel.

Mismatching tire and rim diameters is dangerous. A mismatched tire and rim assembly may separate and can result in serious injury or death. This warning applies to 16" and 16.5" tire and rim assemblies as well as other sized assemblies. **NEVER** assemble a tire and rim unless you have positively identified and correctly matched the tire and rim diameter.

Completely deflate any tire by removing the valve core before removing the tire/wheel assembly from the axle if there is known or suspected damage to the tire or wheel or if the tire has been operated at 80% or less of its recommended operating pressure. Demount, inspect and match all tire and rim parts before re-inflating in a restraining device.

NEVER use starter fluid, ether, gasoline, or other flammable materials and/or accelerants to lubricate the beads of a tire. This practice can cause the explosive separation of the tire/wheel during servicing or during highway use, which may result in serious injury or death.

HOW TO USE THESE TABLES

HOW TO MATCH RIM PARTS

1. Find the stamped identification on the rim base and ring(s). Refer to the pictures (see pictures bottom right) to help find the locations of the stamps. Identify the parts based on the stamps themselves—**DO NOT** identify the parts based only on the way they look.
2. If you cannot find the identification stamp—**STOP!** **NEVER** use a rim part that you cannot identify from the stamp.
3. Match the markings found on the rim base with those shown in the "Rim Base Identification Stamping" column in the tables below.
4. Continue reading the same line across the table to find the proper markings for the matching side ring (or lock ring and flange).
5. **NEVER** assemble mismatched rim parts (see WARNING above). If the identification stamps on the parts do not match—**STOP!** Select serviceable replacement parts from stock or obtain them from a rim supplier.
6. If you are working on a rim/wheel assembly of discontinued parts that are cracked, bent, worn, pitted by corrosion, or unserviceable in any way, for whatever reason—**STOP!** You must replace the entire discontinued assembly with one that is in current production. Examples of unserviceable parts are shown in the photos above.

HOW TO READ THESE TABLES

Example A – Two-Piece Rim/Side Ring Assembly

1. The rim base and side ring to be assembled have identification stamps like the ones shown to the right.

2. Find 20 x 7.5 rim size in the "Rim Size" column in the tables below. Locate 20 x 7.5 FL in the "Rim Base Identification Stamping" column.

3. Continue reading the same line across the table. Find the matching side ring markings in the "Side Ring Identification Stamping" column.

4. One of the proper markings is: 20 x 7.5 FL. This matches the stamp of the side ring shown in the photo. These parts are matched and will make a proper assembly.



Example B – Three-Piece Rim/Side Ring Assembly

1. Follow Steps 1 and 2 in Example A – Two-Piece Assembly.

2. Read across the table in the same row to find the proper match in the "Lock Ring Identification Stamping" and "Flange Identification Stamping" columns.

MULTI-PIECE RIM MATCHING CHART CURRENT PRODUCTION

2-PIECE

Rim Size	Rim Base Identification Stamping	Side Ring Identification Stamping
15 X 6.5	15 X 6.5 LW	R15 X 6.5-7.0 LB-LW
15 X 7.5	15 X 7.5 LW	R15 X 7.5-8.0 LB-LW
20 X 6.5	20 X 6.5 LW	R20 X 6.5-7.0 LB-LW
20 X 7.5	20 X 7.5 FL	R20 X 7.5 FL
	20 X 7.5 LW	R20 X 7.5-8.0-9.0 LB-LW
20 X 8.0	20 X 8.0 LW	R20 X 7.5-8.0-9.0 LB-LW
20 X 9.0	20 X 9.0 LW	R20 X 7.5-8.0-9.0 LB-LW
24 X 8.0	24 X 8.0 LW	R24 X 7.5-8.0-9.0 LB-LW
24 X 9.0	24 X 9.0 LW	R24 X 7.5-8.0-9.0 LB-LW

3-PIECE

Rim Size	Rim Base Identification Stamping	Lock Ring Identification Stamping	Flange Identification Stamping
20 X 7.5	20 X 7.5 M	LR 20 X 7.5-8.5-10.0 M	F 20 X 7.5-8.5 M
	20 X 7.5-5°	20 X 7.0-7.5-8.0-5°	20 X 7.5-8.05°-7.5 FL
20 X 8.0	20 X 8.0-5°	20 X 7.0-7.5-8.0-5°	20 X 7.5-8.05°-7.5 FL
20 X 8.5	20 X 8.5 M	LR 20 X 7.5-8.5-10.0 M	F 20 X 7.5-8.5 M
20 X 10.0	20 X 10.0 M	LR 20 X 7.5-8.5-10.0 M	F 20 X 10.0 M
22 X 8.0	22 X 8.0-5°	22 X 7.0-7.5-8.0-5°	22 X 8.0-5°
24 X 7.5	24 X 7.5 M	LR 24 X 7.5-8.5-10.0 M	F 24 X 7.5-8.5 M
24 X 8.0	24 X 8.0-5°	24 X 7.0-7.5-8.0-5°	24 X 8.0-5°
24 X 8.5	24 X 8.5M	LR 24 X 7.5-8.5-10.0 M	F 24 X 7.5-8.5 M
	24 X 8.5-5°	24 X 8.5-5°	24 X 8.5-5°
24 X 10.0	24 X 10.0 M	LR 24 X 7.5-8.5-10.0 M	F 24 X 10.0 M

MULTI-PIECE RIM MATCHING CHART OUT-OF-PRODUCTION (OBSOLETE)

2-PIECE

Rim Size	Rim Base Identification Stamping	Side Ring Identification Stamping
15 X 5.5	15 X 5.5 LTS; B5515 TS	R15 X 5.5 LTS; R5515 TS
	15 X 5.5 LW; B5515 LW	R15 X 5.5-6.0 LB-LW; R5515 LW; R5015 L
	15 X 5.50 F RHP	15 X 5.00 F RHP; 15 X 4.50E-5.50 F RIP
15 X 6.0	15 X 6.0 LTS; B6015 TS	R15 X 6.0 LTS; R6015 TS
	15 X 6.0 LW; B6015 LW	R15 X 5.5-6.0 LB-LW; R5515 LW
15 X 6.5	B6515 LW	R15 X 6.5-7.0 LB-LWⓄ; R6515 LW; R6015 L
15 X 7.0	15 X 7.0 LW; B7015 LW	R15 X 6.5-7.0 LB-LWⓄ; R6515 LW
	1715 15-7.0	1715 RC15-7.0
15 X 7.5	1115 15-7.5	1115 RC15-7.5
	B7515 LW	R15 X 7.5-8.0 LB-LWⓄ; R8015 LW
	B7515 LB	R8015 LW
16 X 5.5	16 X 5.5 LTS; 16 X 5.50 F-LTS; B5516 TS	R16 X 5.5 LTS; R5516 TS; 16 X 5.50 F-LTS
	16 X 5.50 F RHP	16 X 5.50 F RHP; 16 X 4.50E-5.50 F RIP
	16 X 5.50 F-DUOⓄ	R5516 LTS Ⓞ; 16X5.50F LTSⓄ; DUO 16X5.5 F
16 X 6.0	16 X 6.0 LTS; B6016 TS	R16 X 6.0 LTS; R6016 TS
	16 X 6.00 G RHP	16 X 6.00 G RHP; 16 X 6.00 G RIP
16 X 6.5	16 X 6.5 LTS; B6516 TS	R16 X 6.5 LTS; R6516 TS

20 X 5.0	B5020 LW B5020 KW	R5020 LW R5020 KW
20 X 5.5	B5520 LW 20 X 5.50 F RHP B5520 KW	20 X 5.5-6.0DT-LB-LW [Ⓞ] ; R5520 LW 20 X 5.50 RHP; 20 X 5.50F RIP R5520 KW
20 X 6.0	20 X 6.0 FL 20 X 6.0 LB; B6020 LB; 20 X 6.0 DT-LB [Ⓞ] 20 X 6.0 LW; B6020 LW 20 X 6.0 RH5°; 20 X 6.0 -RH5° 20 X 6.0 XL B6020 KW BW-5 20 X 6.0	20 X 6.0 FL R20 X 5.5-6.0 LB-LW; R5520 LW; 20 X 5.5-6.0DT-LB-LW [Ⓞ] R20 X 5.5-6.0 LB-LW; R5520 LW; 20 X 5.5-6.0DT-LB-LW [Ⓞ] 20 X 6.0 RH5° 20 X 6.0 XL; 20 X 6.0-6.5 XL R5520 KW BW-5 20 X 6.0
20 X 6.5	20 X 6.5 CR; B6520 CR 20 X 6.5 LB; B6520 LB; 20 X 6.5 DT-LB [Ⓞ] B6520 LW 20 X 6.5 RH5°; 20 X 6.5 -RH5° 20 X 6.5 XL B6520 KW BW-5 20 X 6.5	20 X 6.5-7.0 CR; R6520 -CR; R20 X 6.5-7.0 CR R20 X 6.5-7.0 LB-LW [Ⓞ] ; R6520 LW; 20 X 6.5-7.0 DT-LB-LW [Ⓞ] R20 X 6.5-7.0 LB-LW [Ⓞ] ; R6520 LW; 20 X 6.5-7.0DT-LB-LW [Ⓞ] 20 X 6.5 RH5° 20 X 6.5 XL; 20 X 6.0-6.5 XL R6020 K; R6520 K BW-5 20 X 6.5-7.0 T
20 X 7.0	20 X 7.0 CR; B7020 CR 1720 20-7.0; K-H 20 X 7.0 20 X 7.0 LB; B7020 LB; 20 X 7.0 DT-LB [Ⓞ] 20 X 7.0 LW; B7020 LW B7020 KB B7020 KW B7020 KWX 20 X 7.0 BW5°	20 X 6.5-7.0 CR; R20 X 6.5-7.0 CR; R6520 CR 1720 RC20-7.0 R20 X 6.5-7.0 LB-LW [Ⓞ] R6520 LW; 20 X 6.5-7.0 DT-LB-LW [Ⓞ] R20 X 6.5-7.0 LB-LW [Ⓞ] R6520 LW; 20 X 6.5-7.0 DT-LB-LW [Ⓞ] R6520 KW R6520 KW R6520 KW BW-5 20 X 6.5-7.0 T
20 X 7.5	B7520 FL 1020 20-7.5; T/M 20-7.5 8-A3-190 1120 20-7.5; D-13520 20-7.5; A-AA 2951 20-7.5; K-H 20 X 7.5 20 X 7.5 LA; 20 X 7.5 MS; B7520 LA 20 X 7.5 LB; 20 X 7.5DT-LB [Ⓞ] ; B7520LB; G20750B [Ⓞ] 20 X 7.50 LW; B7520 LW; G20750B [Ⓞ] B7520 KB B7520 KW B7520 KWX BW-5 20 X 7.5	20 X 7.5 FL; R20 X 7.5 FL [Ⓞ] ; R7520 FL 1020 RC 20-7.5; T/M 2.0-7.5 8-A3-190 1120 RC 20-7.5; D 2.0-7.5 D 13520 SR; F20-7.5 A-AA 2951-1 R20 X 7.5 LA; 20 X 7.5 MS; R7520 LA R20 X 7.5-8.0-9.0 LB-LW [Ⓞ] ; 20 X 7.5-8.0 DT-LB-LW [Ⓞ] ; R8020 LW R20 X 7.5-8.0-9.0 LB-LW [Ⓞ] ; 20 X 7.5-8.0 DT-LB-LW [Ⓞ] ; R8020 LW R8020 KW R8020 KW R8020 KW BW-5 20 X 7.5
20 X 8.0	20 X 8.00 LW; B8020 LW; G20800B [Ⓞ] B8020 KW	R20 X 7.5-8.0-9.0 LB-LW [Ⓞ] ; 20 X 7.5-8.0 DT-LB-LW [Ⓞ] ; R8020 LW R7520 K
20 X 9.0	B9020 M	R20 X 7.5-8.0-9.0 LB-LW [Ⓞ] ; R8020 LW; R7520 L
20 X 10.0	20 X 10.0 LA; B1020 LA	R20 X 10.0 LA; R1020 LA
22 X 7.5	1022 22-7.5; T/M 22-7.5 8-A3-191 1122 22-7.5; D-13522 22-7.5; A-AA2952 22-7.5 22 X 7.5 FL; B7522 FL 22 X 7.5 LB; 22 X 7.5DT-LB [Ⓞ] ; B7522 LB; G22750B [Ⓞ] 22 X 7.5 LW; 22 X 7.50 LW; B7522 LW; G22750B [Ⓞ] B7522 KB B7522 KW B7522 KWX BW-5 22 X 7.5	1022 RC22-7.5; T/M 22-7.5 8-A3-191 1122 RC22-7.5; D 22-7.5D 13522-SR; F 22-7.5 A-AA2952-1 22 X 7.5 FL; R22 X 7.5 FL; R7522 FL R22 X 7.5-8.0-9.0 LB-LW; 22 X 7.5-8.0 DT-LB-LW [Ⓞ] ; R8022 LW R22 X 7.5-8.0-9.0 LB-LW; 22 X 7.5-8.0 DT-LB-LW [Ⓞ] ; R8022 LW R8022 KW R8022 KW R8022 KW BW-5 22 X 7.5
22 X 8.0	22 X 8.0 LW; 22 X 8.00 LW; B8022 LW; G22800B [Ⓞ] B8022 KW	R22 X 7.5-8.0-9.0 LB-LW; 22 X 7.5-8.0 DT-LB-LW [Ⓞ] ; R8022 LW R7522 KW
24 X 8.0	B8024 LW B8024 KW	R24 X 7.5-8.0-9.0 LB-LW [Ⓞ] ; R8024 LW; R7524 L R7524 K
24 X 9.0	B9024 M	R24 X 7.5-8.0-9.0 LB-LW [Ⓞ] ; R8024 LW; R7524 L
24 X 10.0	24 X 10.0 LA; B1024 LA	R24 X 10.0 LA; R1024 LA

MULTI-PIECE RIM MATCHING CHART OUT-OF-PRODUCTION (OBSOLETE)





3-PIECE

Rim Size	Rim Base Identification Stamping	Lock Ring Identification Stamping	Flange Identification Stamping
15 X 7.0	15 X 7.0-5°	15 X 7.0-7.5-8.0-5°	15 X 7.0-5°
15 X 7.5	15 X 7.5-5°	15 X 7.0-7.5-8.0-5°	15 X 7.5-5°
20 X 5.0	20 X 5.0	20 DIA	20 X 5
20 X 6.0	20 X 6.0-5°	20 X 6.0-5°	20 X 6.0-5°-FL
	20 X 6.0 FL	20 X 6.0 FL	20 X 6.0-5°-FL
	20 X 6.0	20 DIA	20 X 6
	BW-5 20 X 6.0	BW-5 20 X 6.5-7.0 T	BW-5 20 X 6.0
20 X 6.5	20 X 6.5-5°	20 X 6.5-5°	20 X 6.5-5°-CR; F6520 CR
	20 X 6.5 CR; B6520 CR	20 X 6.5-7.0 CR; LR6520 CR; LR20 X 6.5-7.0 CR	20 X 6.5-5°-FL-CR; F6520 CR; F20X6.5 CR
	20 X 6.5	20 DIA	20 X 6.5
20 X 7.0	20 X 7.0 CR; B7020 CR	20 X 6.5-7.0 CR; LR6520 CR; LR20 X 6.5-7.0 CR	20 X 7.0-5°-FL-CR; F7020 CR; F20 X 7.0 CR; 20 X 7.0-5°-FL-CR-8.00 RTH
	20 X 7.0-5°	20 X 7.0-7.5-8.0-5°	20 X 7.0-5°-FL-CR-8.00 RTH; F7020 CR; 20 X 7.0-5°-FL-CR
	20 X 7.0 BW5°	BW-5 20 X 6.5-7.0 T	BW-5 20 X 6.5-7.0 T
20 X 7.5	B7520 FL	20 X 7.5 FL; LR20 X 7.5 FL; LR7520 FL	20 X 7.5-5°-FL; 20 X 7.5-8.05°-7.5 FL; F20 X 7.5 FL; F7520 FL
	20 X 7.5 M④	LR20 X 7.5-8.5-10.0 M④; LR20 M	F20 X 7.5-8.5 M④; F7520 M
	20 X 7.50-5°; F20750 B②	20 X 7.0-7.5-8.0-5°④	20 X 7.5-5°-FL; 20 X 7.5-8.05°-7.5 FL④; F7520 FL
20 X 8.0	20 X 8.00-5°; F20800 B②	20 X 7.0-7.5-8.0-5°	20 X 8.0-5°; 20 X 7.5-8.05°-7.5 FL④
	BW-5 20 X 8.0	BW-5 20 X 7.5-8.0V-8.5V	BW-5 20 X 8.0V-8.5V
20 X 8.5	20 X 8.5-5°	20 X 8.5-5°	20 X 8.5-5°
	20 X 8.5 M④	LR20 X 7.5-8.5-10.0 M④; LR20 M	F20 X 7.5-8.5 M④; F7520 M
20 X 10.0	B1020 M	LR20 X 7.5-8.5-10.0 M④; LR20 M	F20 X 10.0 M④; F1020 M
22 X 7.5	22 X 7.5-5°; 22 X 7.50-5°; F22750 B②	22 X 7.0-7.5-8.0-5°	22 X 7.5-5°-FL; 22 X 7.5-8.05°-FL; F22 X 7.5 FL; F7522 FL; 22 X 7.5-8.05°-7.5 FL
	22 X 7.5 FL; B7522 FL	22 X 7.5FL; LR22 X 7.5 FL; LR7522 FL	22 X 7.5-5°-FL; 22 X 7.5-8.05°-FL; F22 X 7.5 FL; F7522 FL; 22 X 7.5-8.05°-7.5 FL
	22 X 7.5 M	LR22 M; LR22 X 7.5-8.5-10 M	F7522 M
	BW-5 22 X 7.5	BW-5 22 X 7.5-8.0V-8.5V	B-5° 22 X 7.5
22 X 8.0	22 X 8.00-5°; F22800 B②	22 X 7.0-7.5-8.0-5°④	22 X 8.0-5°④
	BW-5 22 X 8.0	BW-5 22 X 7.5-8.0V-8.5V	BW5 22 X 8.0V-8.5V
24 X 7.5	24 X 7.5 M④	LR24 X 7.5-8.5-10.0 M④; LR24 M	F24 X 7.5-8.5 M④; F7524 M
	24 X 7.5-5°	24 X 7.0-7.5-8.0-5°④	24 X 7.5-5°; 24 X 7.5-8.0-5°; 24 X 8.0-5°④
24 X 8.0	24 X 8.0-5°④	24 X 7.0-7.5-8.0-5°④	24 X 7.5-8.0-5°; 24 X 8.0-5°④
24 X 8.5	24 X 8.5 M	LR24 X 7.5-8.5-10.0 M④; LR24 M	F24 X 7.5-8.5 M④; F7524 M
24 X 10.0	B1024 M	LR24 X 7.5-8.5-10.0 M④; LR24 M	F24 X 10.0 M④; F1024 M

NOTES

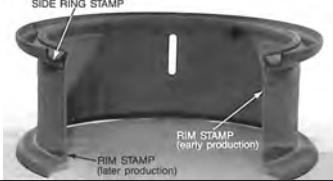
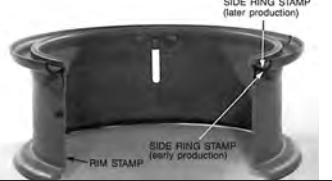
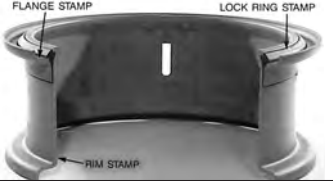
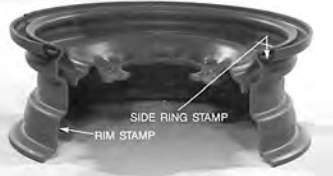
- ① Wheel numbers 86130, 86140, 86680, 86940, 87160, 87430, 87440, 87500, 87510, 87560, 87740, 88540, 88630 associated with the 16 x 5.50 F Duo rim use LTS rings. All other DUO rims use “C” section side rings (DUO 16 x 5.50 F).
- ② Some aluminum wheel stampings are followed by a character (X-T-N-B) which indicates a finished surface condition. This does not affect the interchangeability of the parts as shown on this table.
- ③ “DT”, “LB”, “LW” and “DT-LB-LW” are interchangeable components.
- ④ This product is still being manufactured for use with other components.

EXAMPLES OF TYPICAL RIM CONTOURS AND IDENTIFICATION STAMP LOCATIONS

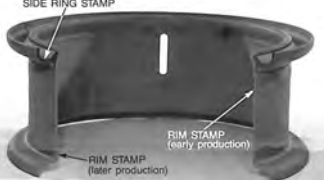
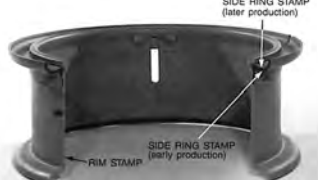
2-PIECE CURRENT PRODUCTION: CR, DT, FL, LA, LB, LW, MS	2-PIECE CURRENT PRODUCTION: REDCO	3-PIECE CURRENT PRODUCTION: 5°, CR, FL, M
		
DISCONTINUED: DUO, LTS, RHP	DISCONTINUED: AR	DISCONTINUED: RH5°
		
DISCONTINUED: XL, RIP	DISCONTINUED: K, K28, KB, KW, KWX	DISCONTINUED: GREAT DANE, K-H, DORSEY, TRAILMOBILE, STRICK CORP, FRUEHAUF
		

You have a right to a safe workplace.
 If you have questions about workplace safety and health, call OSHA at 1-800-321-OSHA (6742).
It's confidential.
 We can help!

OSHA® **Occupational Safety and Health Administration**
 U.S. Department of Labor
 www.osha.gov • (800) 321-OSHA (6742) • TTY (877) 889-5627



U.S. Department of Labor

www.osha.gov • (800) 321-OSHA (6742) • TTY (877) 889-5627